

Data Sheet



Article number: 12621000035000

Description: Industrial tool 621 000 035.000
For M3,5

Measures

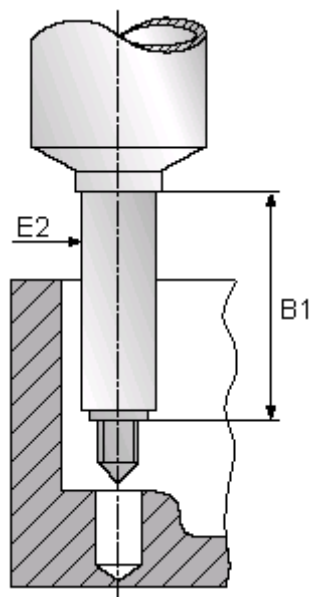

B1 = 40

E2 = 7

For thread = M3,5